



Manual Installation Instructions

Note: The Fire Ring should not sit deeper than 1/2" below the Top Lip of the bowl.

1. Using 1/4" Pea Gravel, fill the lower area of the bowl to 1/2" below the Top Lip of the bowl.
2. Place the Fire Ring on top of Pea Gravel, making sure it is centered.
3. Top the bowl with Fire Glass or Lava Rock.

Manual Light

Remote Module AEWIS

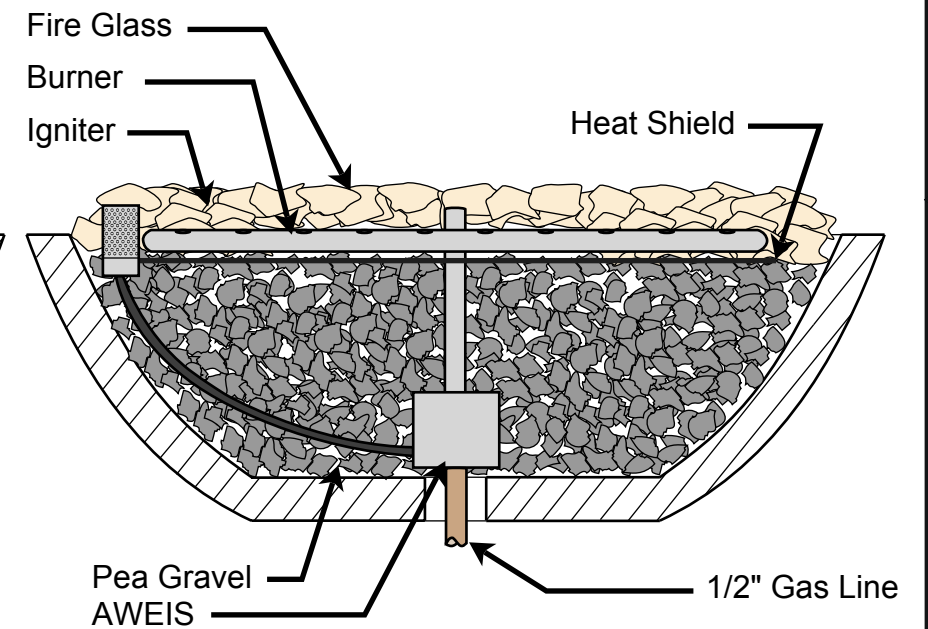
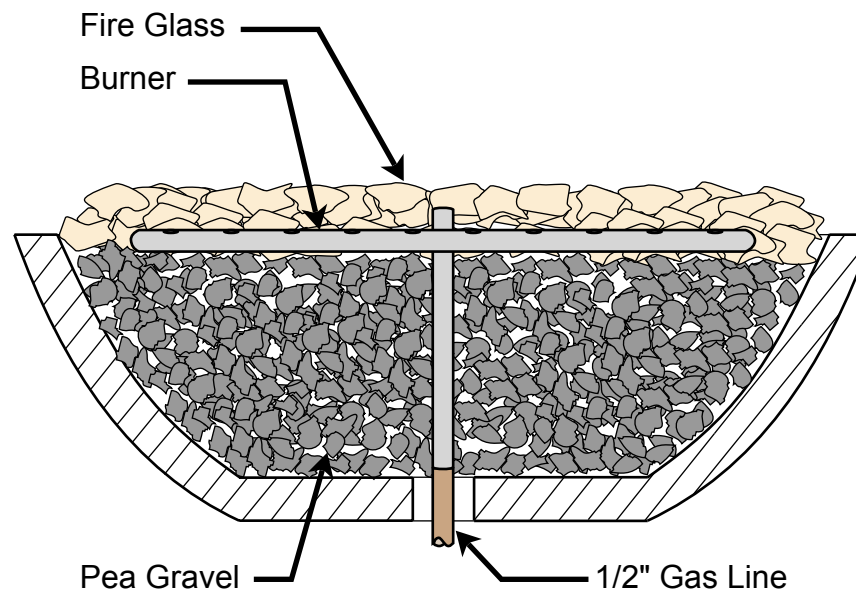
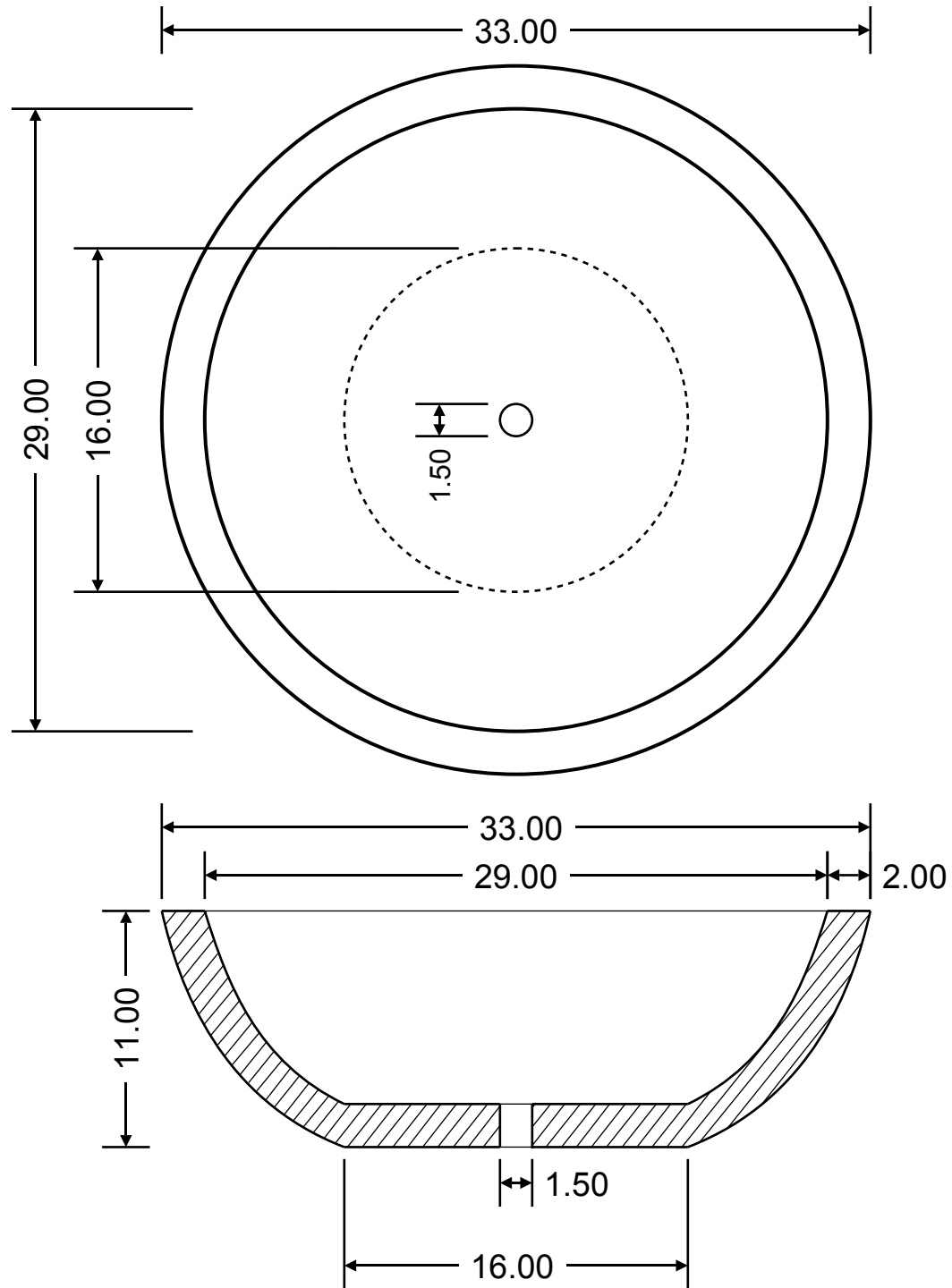

Concrete bowls are formed with fiber reinforced concrete with a water sealer additive and color all through the bowl. Cured for strength and durability.

**Concrete Fire Bowl
Round
33"**

BackyardBlaze

The information contained in this Drawing is the sole property of Backyard Blaze. Any reproduction in part or as a whole without the written permission of Backyard Blaze is prohibited.

Dimensions are in Inches

Size

File No.

WS2107

Rev

1 / 27 / 2014

Scale 1:8

Drawn: Edward Morgan

Sheet 1

